

**1319nm Infrared DPSS Low Noise Laser**



†**Specifications**

Product Code	SSL - 1319 - XXXX - LN
Wavelength [ nm ]	1319
Output Power [ mW ]	600 - 2000
Transverse Mode	TEM <sub>00</sub> / CW
Operating Temperature [ °C ]	+10 - +35
Storage Temperatures [ °C ]	-10 - +45
Warm-up Time [ minutes ]	< 15
Power Stability [ rms, over 4 hours ]	5%, 3%, 1%
M <sup>2</sup> Factor	< 1.5
Beam Diameter At The Aperture [ mm ]	~ 2.5
Beam Divergence, Full Angle [ mrad ]	< 2.0
Spectral Linewidth [ nm ]	< 0.1
Polarization Ratio	> 100 : 1
Point Stability After Warm-up [ mrad ]	< 0.05
Noise of Amplitude [ rms ]	< 1%
Laser Head Dimensions [ mm ]	160 [L] × 78 [W] × 60 [H]
Power Supply Dimensions [ mm ]	235 [L] × 145 [W] × 100 [H]
Working Voltage [ VAC ]	85~245, 50/60Hz
Laser Gross Weight [ kg ]	3.0
Cooling Way	Cooled by TEC and air
Expected Lifetime [ hours ]	> 10000
Warranty Time [ year ]	1

**Laser Head Dimension:**

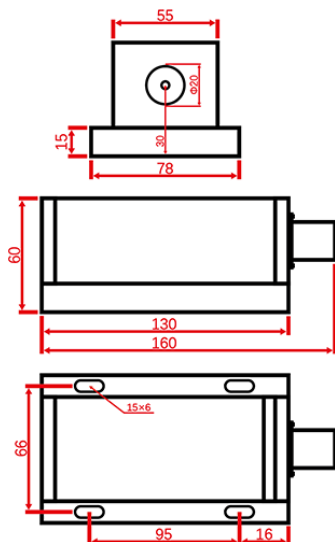

**Power Supply Dimension:**

