

660nm Red Diode Low Noise Laser



†**Specifications**

| | |
|--|-----------------------------|
| Product Code | SSL - 660 - XXXX - LN - LED |
| Wavelength [nm] | 660 ±5 |
| Output Power [mW] [0 - Max Adjustable] | 2100 - 3000 |
| Transverse Mode | TE ₀₀ / CW |
| Operating Temperature [°C] | +10 - +35 |
| Storage Temperatures [°C] | -10 - +45 |
| Warm-up Time [minutes] | < 5 |
| Power Stability [rms, over 4 hours] | 5%, 3%, 1% |
| M ² Factor | < 15 |
| Beam Diameter At The Aperture [mm] | 5.0 × 6.0 |
| Beam Divergence, Full Angle [mrad] | < 3.0 |
| Spectral Linewidth [nm] | < 1.5 |
| Polarization Ratio | > 50 : 1 |
| Point Stability After Warm-up [mrad] | < 0.05 |
| Noise of Amplitude [rms] | < 1% |
| Laser Head Dimensions [mm] | 210 [L] × 86 [W] × 75 [H] |
| Power Supply Dimensions [mm] | 260 [L] × 145 [W] × 105 [H] |
| Working Voltage [VAC] | 85~245, 50/60Hz |
| Laser Gross Weight [kg] | 4.5 |
| Cooling Way | Cooled by TEC and air |
| Expected Lifetime [hours] | > 10000 |
| Warranty Time [year] | 1 |

Laser Head Dimension:

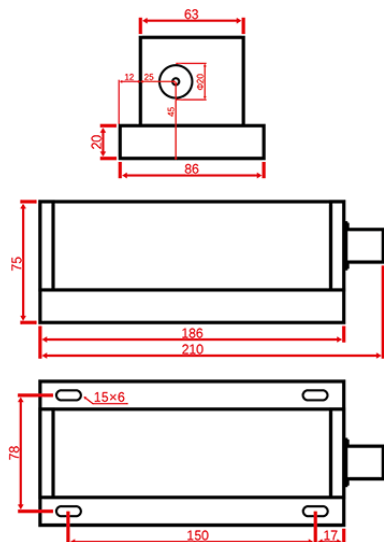

Power Supply Dimension:

